





































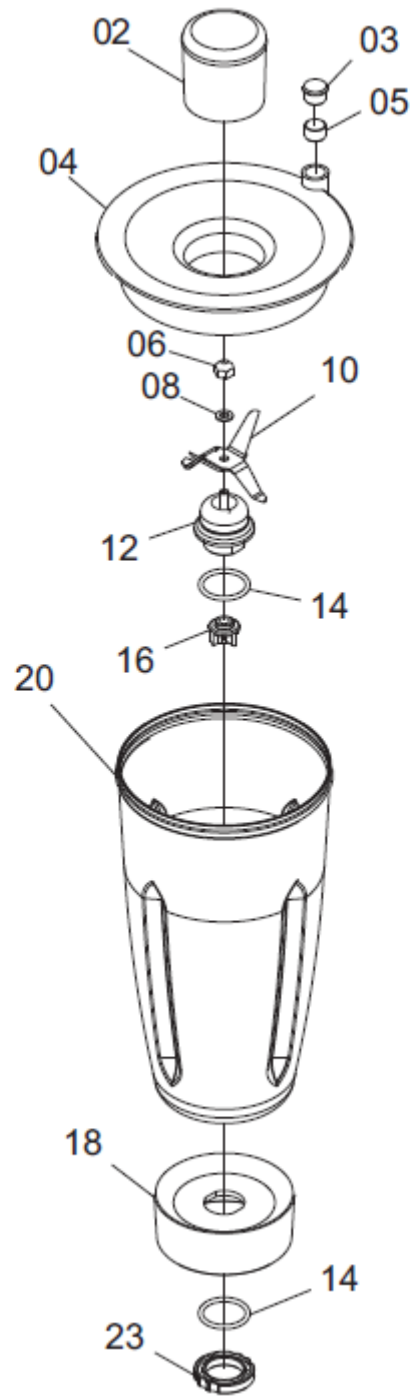





**DRAGONE CE - from 2014.06**









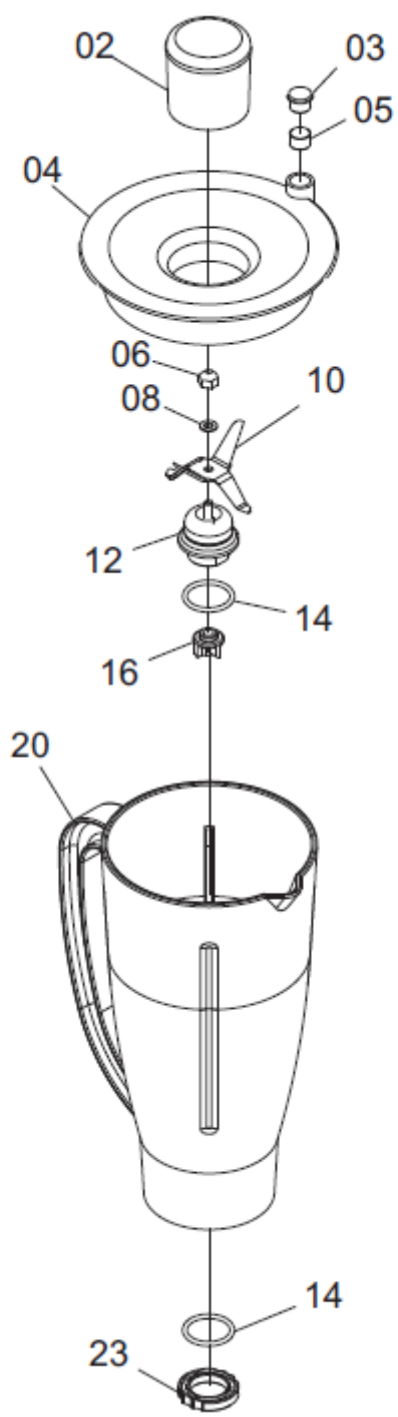



	REF	ART	COD
	25	RONDELLA SUPP.MOTORE DRG	IB2280160
	26	RUBBER GEAR CV75 _ DRAGONE/SATURNO	★ IB4000816
	27	SUPP.ALL.TRASC.GOMMA Y10 DRG	IB2100813
	40	MOTOR SUPPORT FOR DRAGONE	IB4000810
	42	MICROSWITCH FOR BLENDER	IB5820800
	44	NUT M3	IB76D03M
	46	SHAFT - MICROSWITCH DRAGONE	IB2180800
	47	SHAFT - MICROSWITCH DRAGONE	IB1920800
	48	MAGNET FOR BLENDER	IB5820805
	49	CAP FOR BLENDER	IB4000800
	50	BODY FOR DRAGONE, WHITE COLOR	IB4020800
	50	CORPO CROMATO DRG	IB4080800
	50	CORPO ROSSO DRG	IB4030800
	60B	MOTORE 115V/60HZ DRG	IB5000808
	60A	MOTOR 230/50 _ DRAGONE	IB5000800
	100B	SCHEDA FILTRO VV 110/60 DRG	IB5940808
	100A	PC BOARD VV 230 V _ DRAGONE	IB5940800
	104	ON/OFF SWITCH _ SIRIO/APOLLO	★ IB5800100
	106	TERMINAL BLOCK	IB5906410
	108	STRAIN RELIEF PVC DIA 7	IB5890700
	110	STRAIN RELIEF PA 228	IB5900700
	112	SPEED VARIATOR KNOB	IB4200701
	114B	POTENZ.110/60 DRG VV	IB5940021
	114A	POTENZ.220/50 DRG VV	IB5940020
	118	BLACK BOTTOM COVER _ APOLLO/DRAGONE	IB4000710
	122	FUSSE FUER ORIONE	IB4306400
	124A	SHUKO CORD	IB5503000
	124B	CAVO ALIMENTAZIONE TF	IB5503003



**DRAGONE CE - from 2014.06**

	REF	ART	COD	€
	02	GUMMI FUER DECKEL	IB4050905	
	03	HALTER MAGNET DRAGONE	IB4000805	
	04	LID WITH MAGNET FOR DRAGONE	IB4000821	
	05	MAGNET DRAGONE	IB5820810	
	06	SHAFT NUT _ DRAGONE Y15	IB2000944	
	08	S/STEEL WASHER D.05 _ APOLLO/DRAGON	IB77R05	
	10	BLADES ASS.Y _ DRAGONE / SATURNO	IB2680801	
	12	BEARINGS ASSEMBLY FOR DRAGONE	IB9867005	
	14	OR 3100 _ DRAGONE/SATURNO	IB4104033	
	16	BLADE DRIVER M6 SX DRAGONE	IB2100812	
	18	SUPP.BICCH.INOX DRG Y.13	IB4000812	
	20	S/STEEL JUG DRAGONE (FROM 2014/06)	IB2260920	
	23	RETAINING RING BEARING _ DRAGONE	IB2000813	



	REF	ART	COD	€
	02	GUMMI FUER DECKEL	IB4050905	
	03	HALTER MAGNET DRAGONE	IB4000805	
	04	LID WITH MAGNET FOR DRAGONE	IB4000821	
	05	MAGNET DRAGONE	IB5820810	
	06	SHAFT NUT _ DRAGONE Y15	IB2000944	
	08	S/STEEL WASHER D.05 _ APOLLO/DRAGON	IB77R05	
	10	BLADES ASS.Y _ DRAGONE / SATURNO	IB2680801	
	12	BEARINGS ASSEMBLY FOR DRAGONE	IB9867005	
	14	OR 3100 _ DRAGONE/SATURNO	IB4104033	
	16	BLADE DRIVER M6 SX DRAGONE	IB2100812	
	20	LEXAN JAR L.1,5L DRG	IB4050802	
	23	RETAINING RING BEARING _ DRAGONE	IB2000813	